

CONSTRUCTION MATERIALS		
SHELL	TUBES	END COVERS
CARBON STEEL*	COPPER*	CAST IRON*
STAINLESS STEEL	STAINLESS STEEL	STAINLESS STEEL
BRASS	CuNi (water sea)	BRONZE

*standard

- Dimensions and technical characteristics are not binding

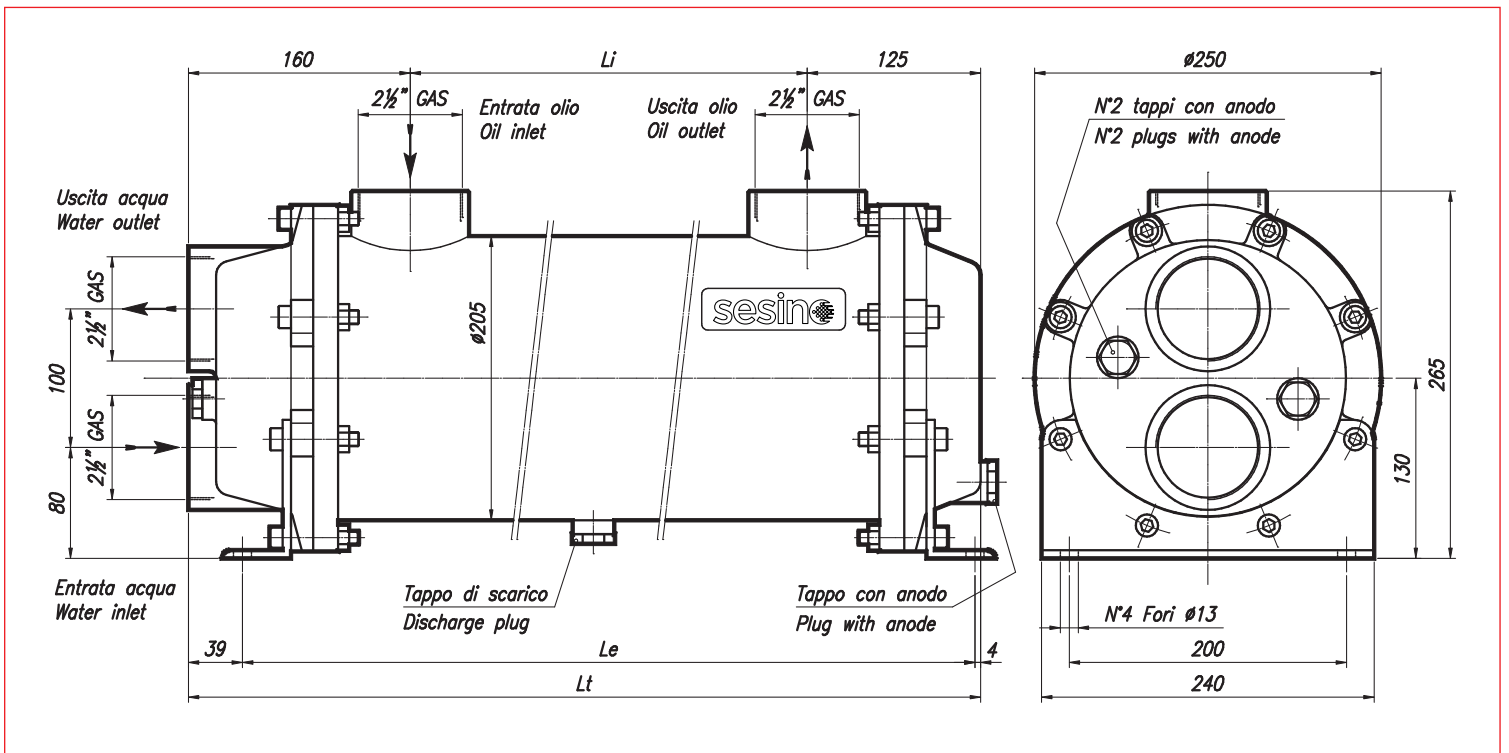

TYPE	CODE	OIL FLOW	WATER FLOW	kW MIN water flow		kW MAX water flow		WEIGHT	DIMENSIONS		
		l/min	l/min	ΔTm 25° C		ΔTm 25° C			kg	Li	Le
MS 202 P1	2SC202P1	100-400	105-420	20	35	24	51	47	340	582	630
MS 202 P2	2SC202P2	160-460	105-420	29	50	39	69	56	500	742	790
MS 202 P3	2SC202P3	280-500	105-420	42	57	56	82	72,5	660	902	950
MS 202 P4	2SC202P4	260-560	105-420	46	76	67	109	84	820	1062	1110
MS 202 P5	2SC202P5	300-600	105-420	56	78	79	125	94	980	1222	1270
MS 202 P6	2SC202P6	340-600	105-420	73	98	98	148	104	1140	1382	1430
MS 202 P7	2SC202P7	280-600	105-420	68	90	92	123	114	1300	1542	1590
MS 202 P8	2SC202P8	200-600	105-420	102	134	141	177	124,5	1460	1702	1750
MS 202 P9	2SC202P9	460-800	105-420	132	168	176	221	135	1620	1862	1910
MS 202 P10	2SC202P10	520-800	105-420	145	197	191	260	145,5	1780	2022	2070

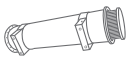

WATER FLOW RATE:



P1 P2 P3

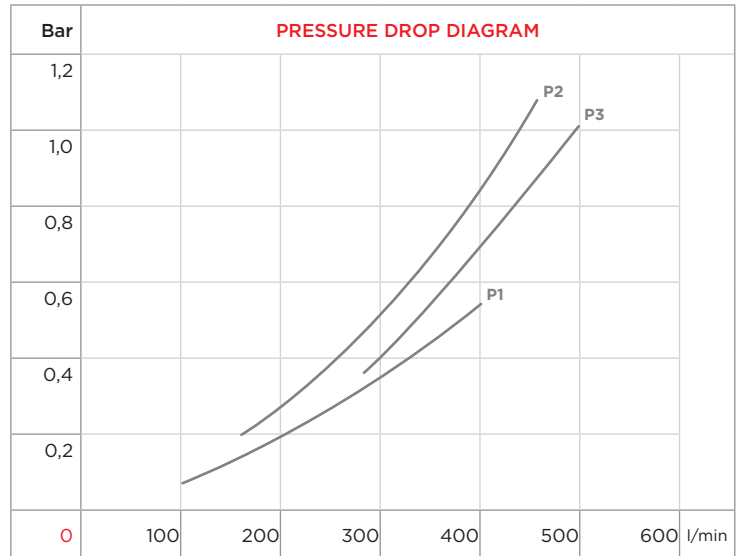
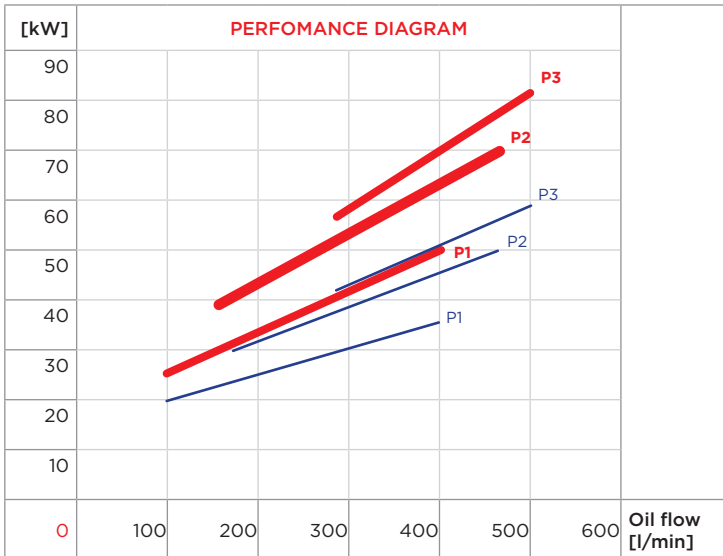

P4 P5 P6

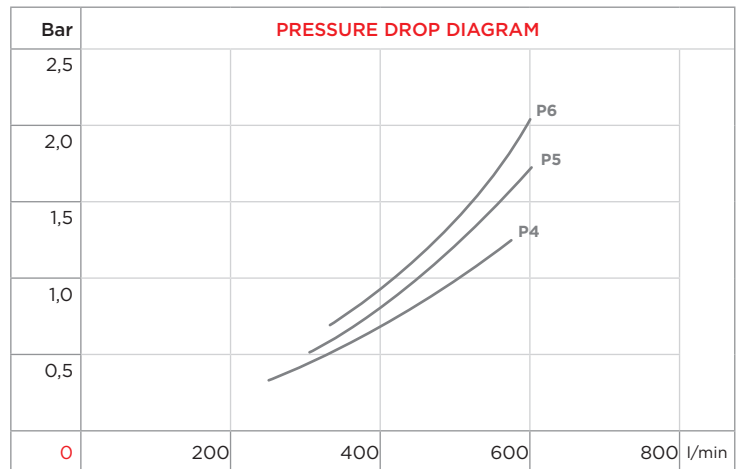
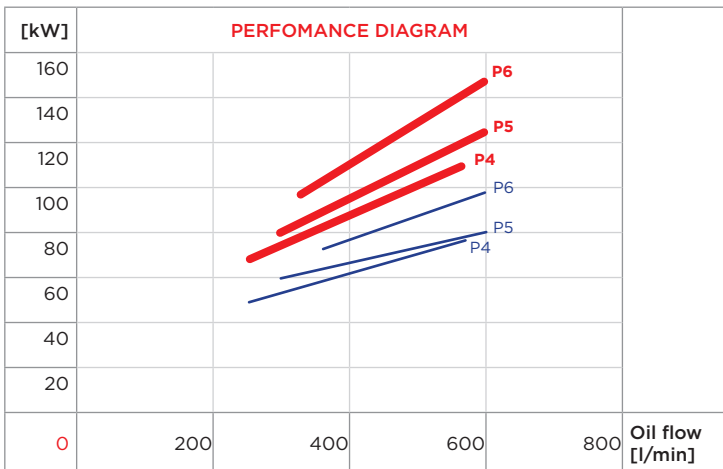

P7 P8 P9 P10

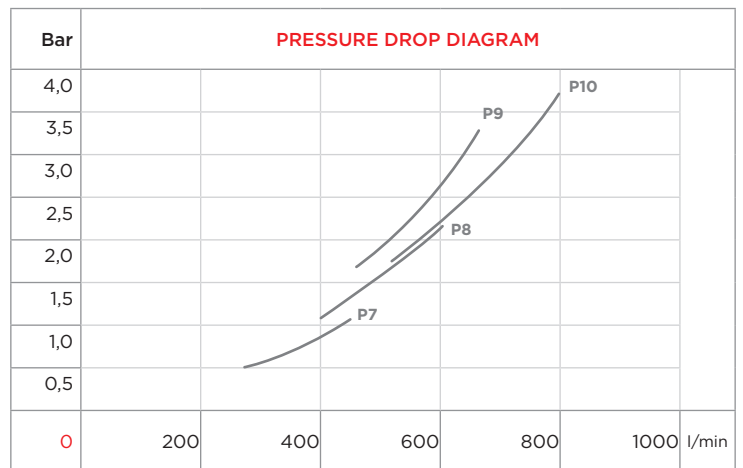

CORRECTION FACTOR							
ΔT_m	10	15	20	25	30	35	40
f	2,5	1,67	1,25	1	0,83	0,71	0,63

CORRECTION FACTOR							
cSt	22	30	46	68	100	150	220
f	0,4	0,6	1	1,5	2,3	3,3	4,6

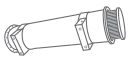

CONSTRUCTION MATERIALS		
SHELL	TUBES	END COVERS
CARBON STEEL*	COPPER*	CAST IRON*
STAINLESS STEEL	STAINLESS STEEL	STAINLESS STEEL
BRASS	CuNi (water sea)	BRONZE

*standard

- Dimensions and technical characteristics are not binding

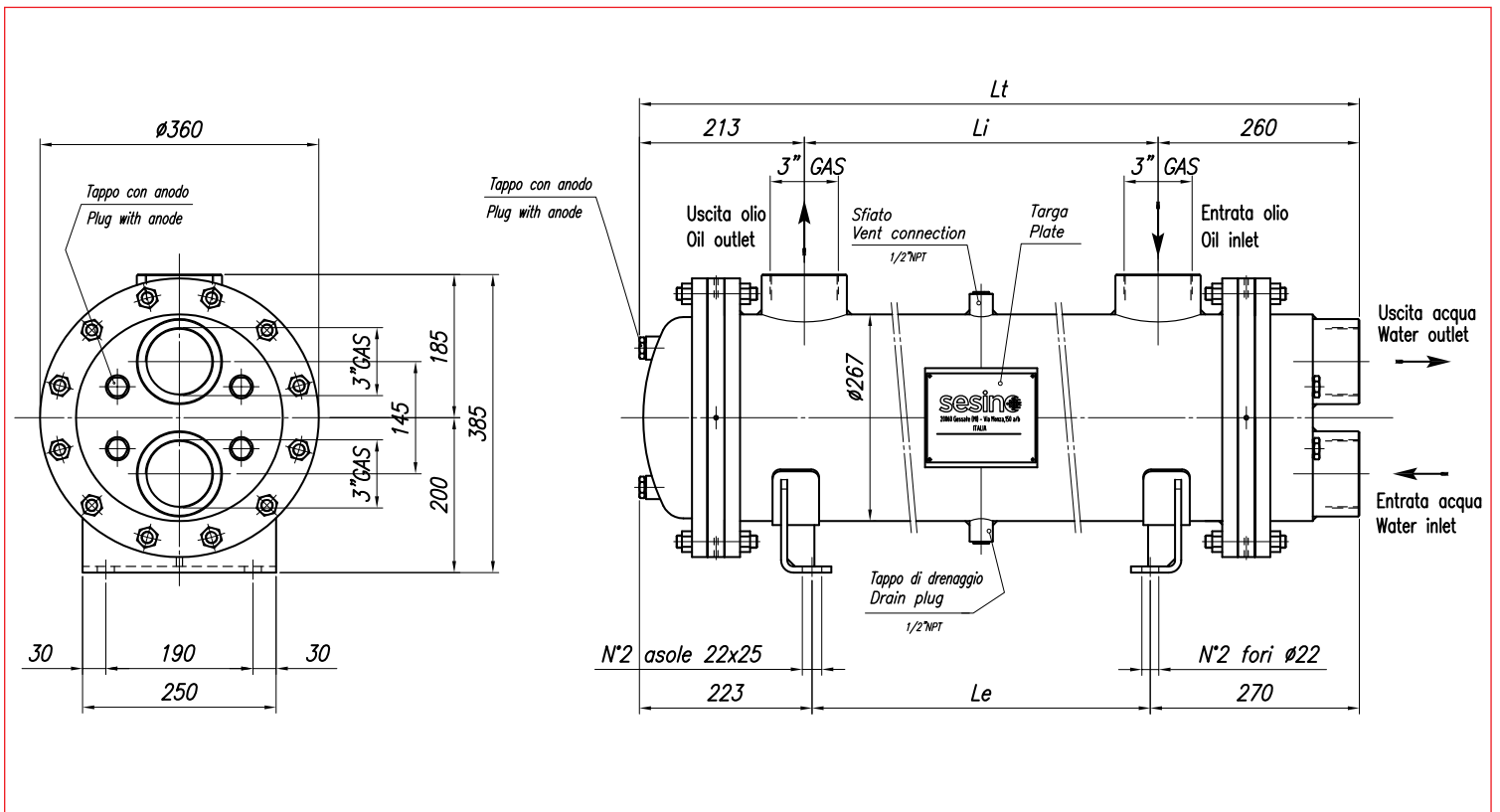

TYPE	CODE	OIL FLOW	WATER FLOW	kW MIN water flow		kW MAX water flow		WEIGHT	DIMENSIONS		
		l/min	l/min	ΔTm 25° C		ΔTm 25° C			kg	Li	Le
MS 272 P1	2SC272P1	190-350	146-583	28	36	37	51	142	255	235	728
MS 272 P2	2SC272P2	250-410	146-583	48	60	64	78	160	385	365	858
MS 272 P3	2SC272P3	310-450	146-583	56	66	81	97	172	505	485	978
MS 272 P4	2SC272P4	250-500	146-583	93	114	135	166	214	850	830	1323
MS 272 P5	2SC272P5	300-560	146-583	124	146	181	204	236	1040	1020	1513
MS 272 P6	2SC272P6	300-600	146-583	158	182	239	277	273	1360	1340	1833
MS 272 P7	2SC272P7	460-740	146-583	214	242	335	376	327	1825	1805	2298

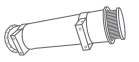

WATER FLOW RATE:



P1 P2 P3

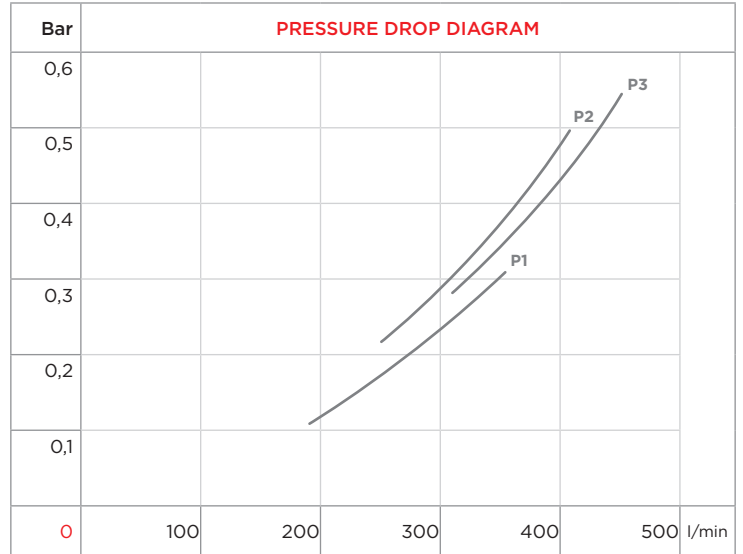
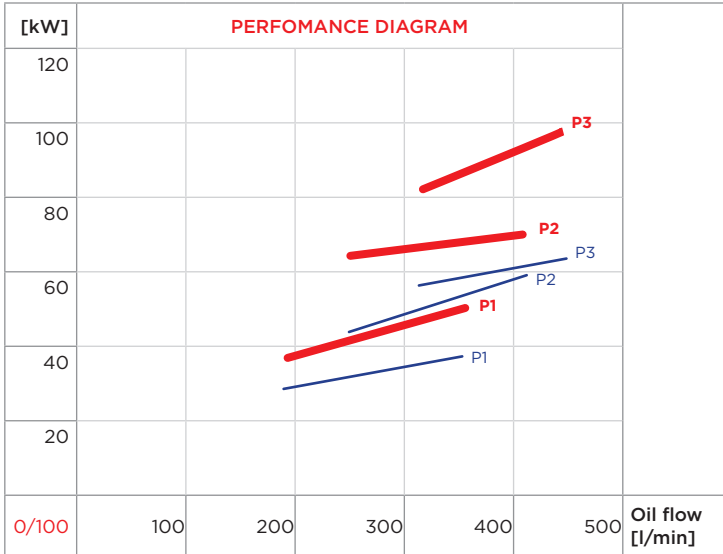

P4 P5 P6

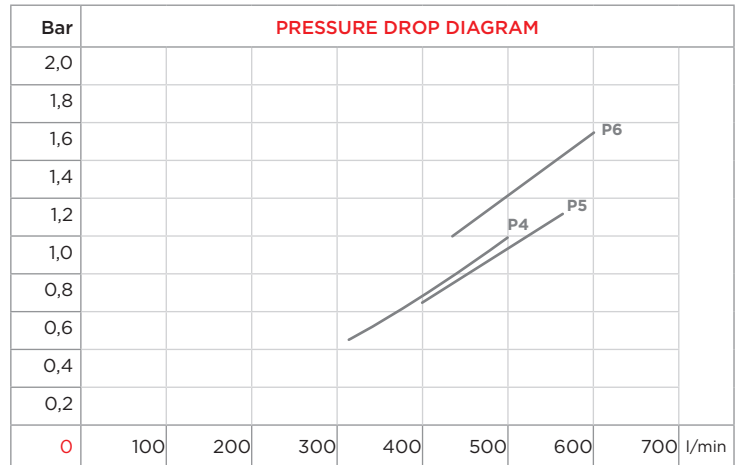

P7

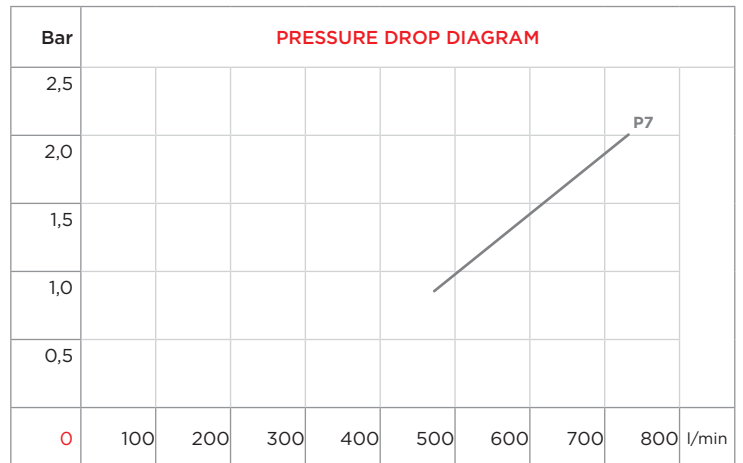
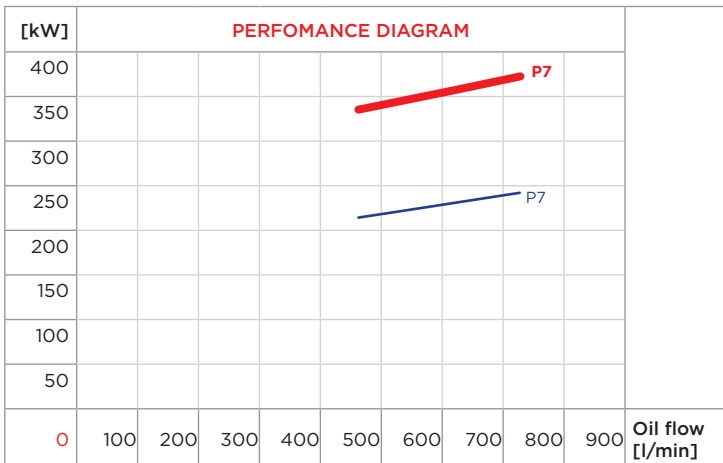

ΔT_m	10	15	20	25	30	35	40
f	2,5	1,67	1,25	1	0,83	0,71	0,63

cSt	22	30	46	68	100	150	220
f	0,4	0,6	1	1,5	2,3	3,3	4,6

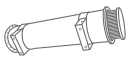

CONSTRUCTION MATERIALS		
SHELL	TUBES	END COVERS
CARBON STEEL*	COPPER*	CAST IRON*
STAINLESS STEEL	STAINLESS STEEL	STAINLESS STEEL
BRASS	CuNi (water sea)	BRONZE

*standard

- Dimensions and technical characteristics are not binding

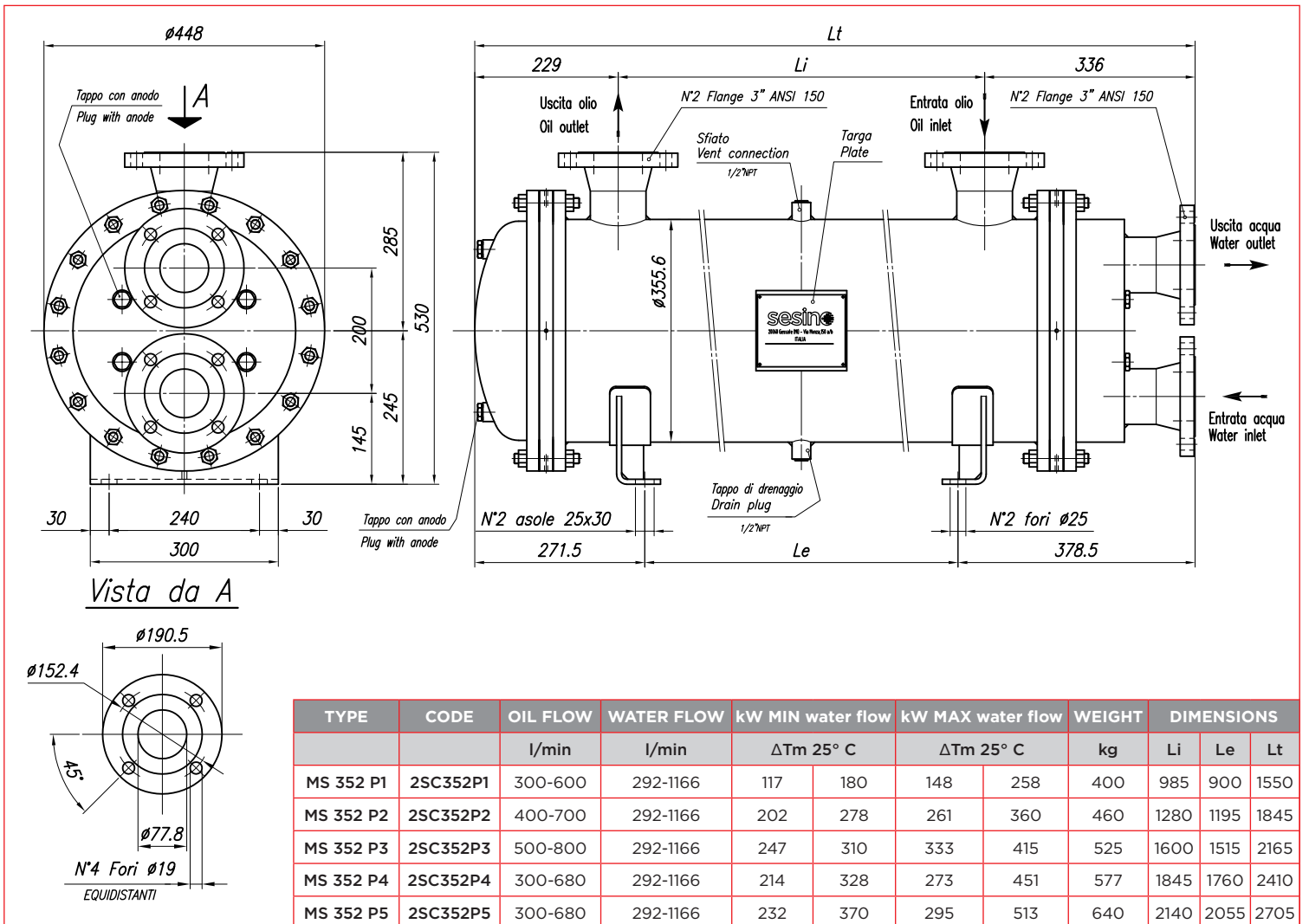

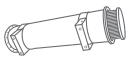

WATER FLOW RATE:

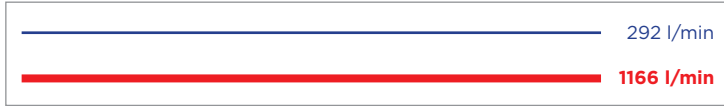

P1 P2

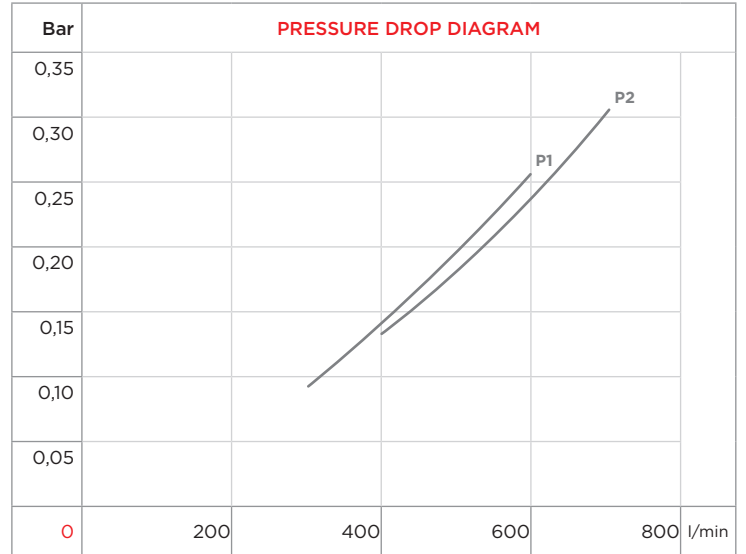
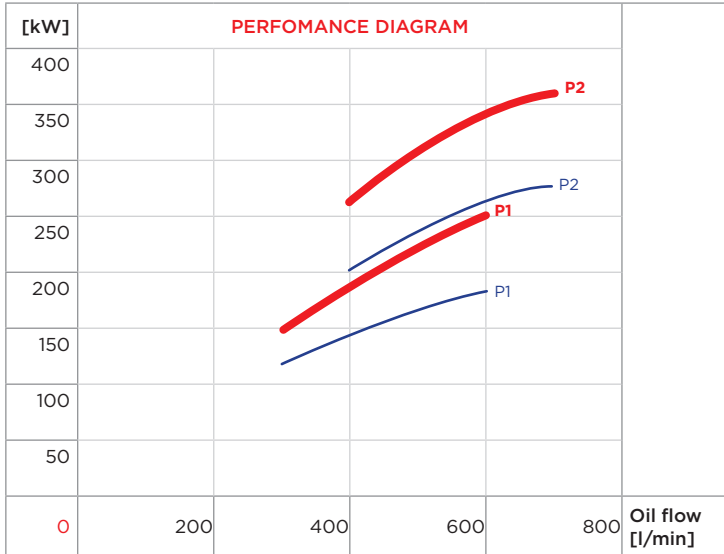

P3 P4

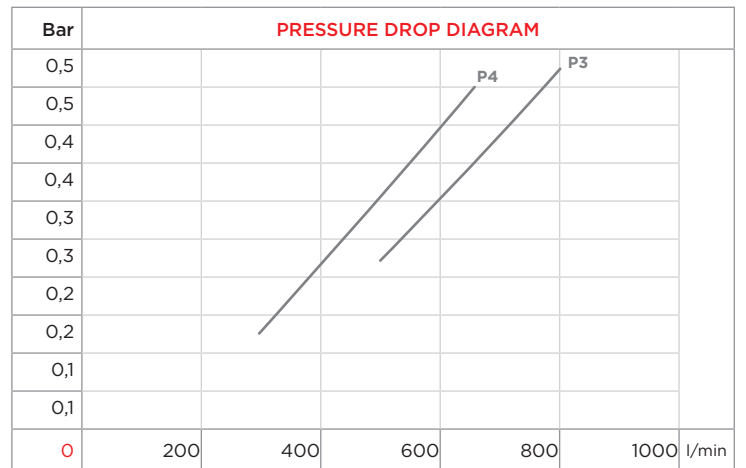
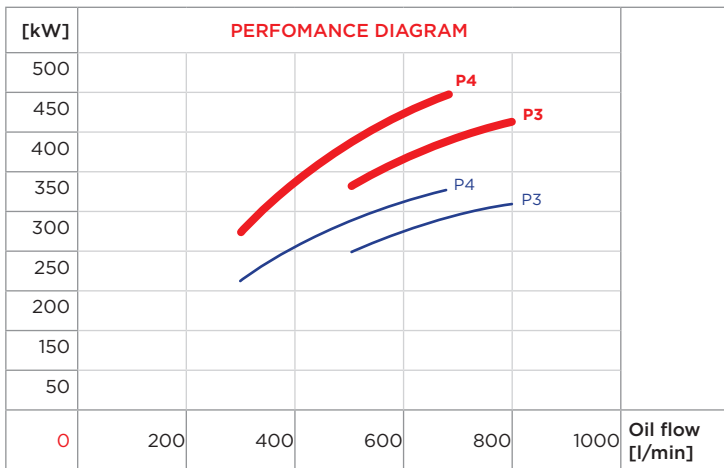

P5

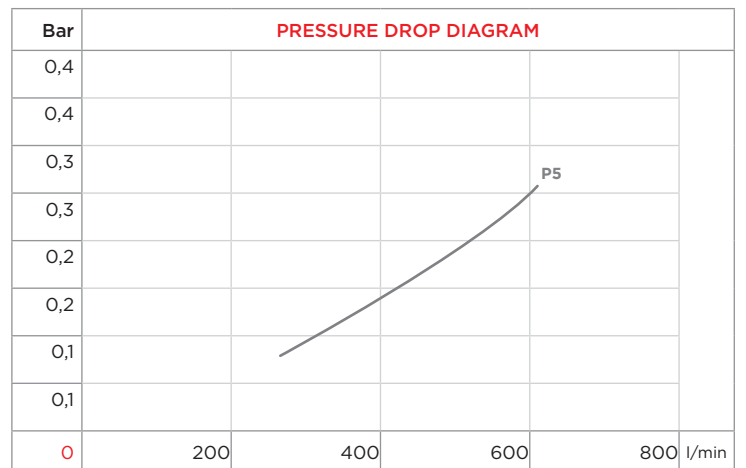
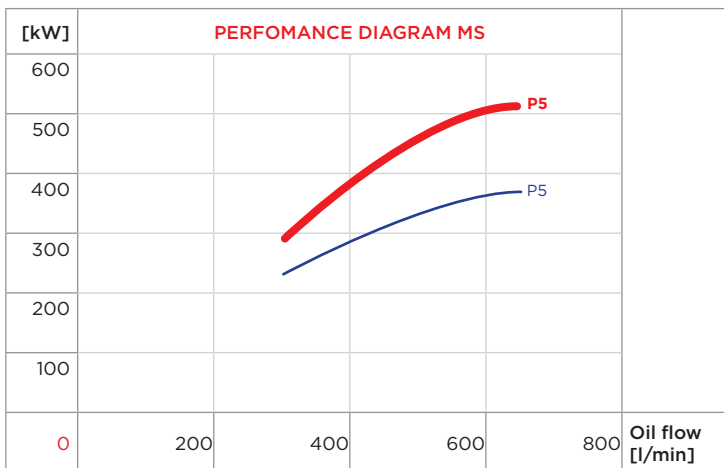

CORRECTION FACTOR							
ΔT_m	10	15	20	25	30	35	40
f	2,5	1,67	1,25	1	0,83	0,71	0,63

CORRECTION FACTOR							
cSt	22	30	46	68	100	150	220
f	0,4	0,6	1	1,5	2,3	3,3	4,6

MS 152/7 P

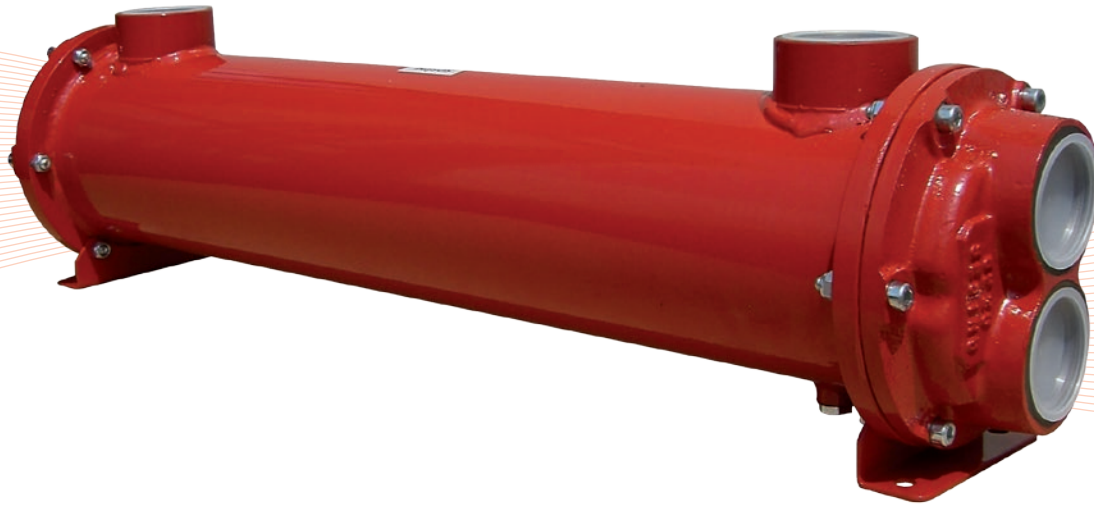
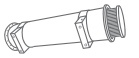

CONSTRUCTION MATERIALS		
SHELL	TUBES	END COVERS
CARBON STEEL*	COPPER*	CAST IRON*
STAINLESS STEEL	STAINLESS STEEL	STAINLESS STEEL
BRASS	CuNi (water sea)	BRONZE



- Dimensions and technical characteristics are not binding

*standard

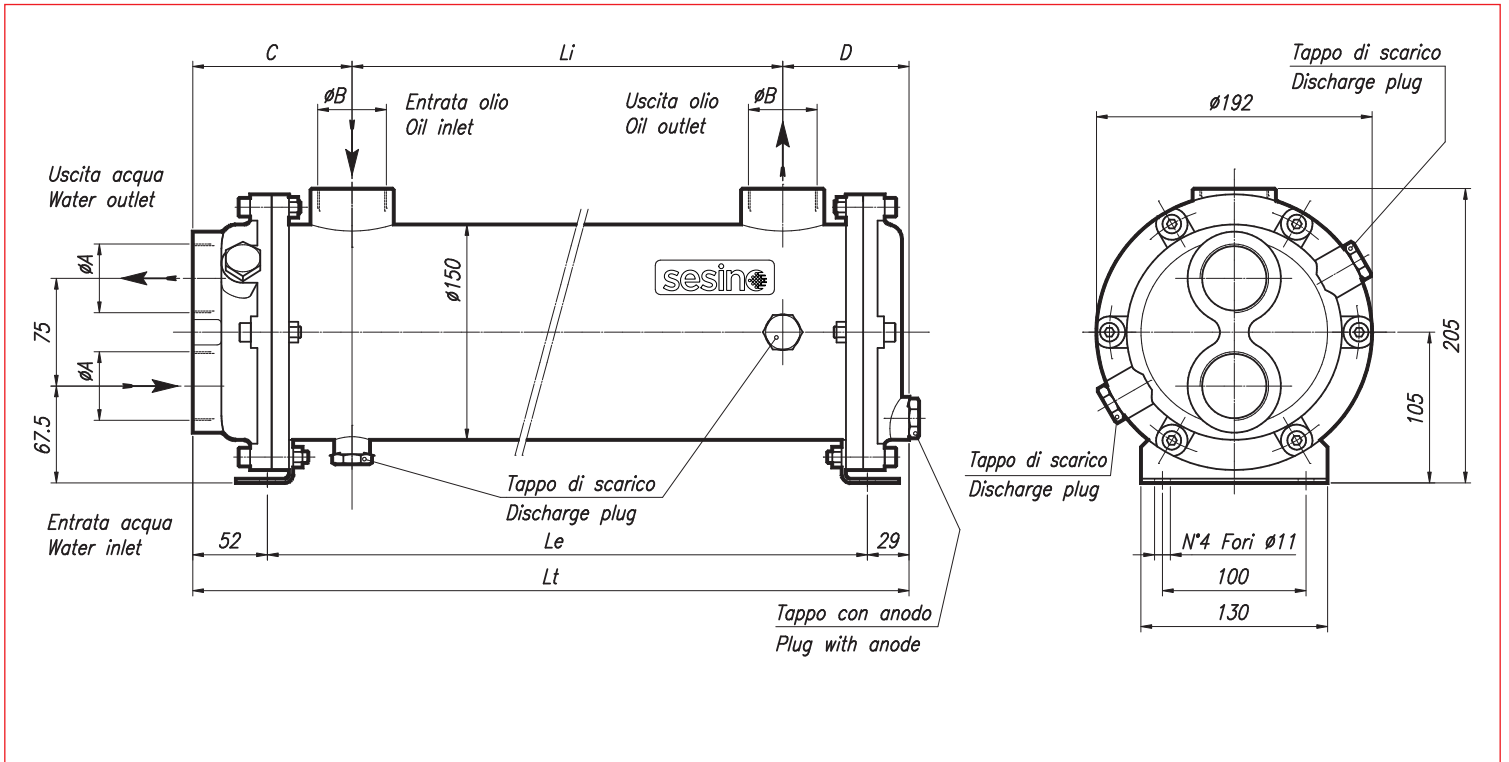

TYPE	CODE	OIL FLOW l/min	WATER FLOW l/min	kW MIN water flow		kW MAX water flow		WEIGHT kg	DIMENSIONS						
				ΔTm 25° C		ΔTm 25° C			ϕA	ϕB	C	D	Li	Le	Lt
MS 152/7 P1	2SC152/7P1	40-120	40-160	4,5	6,9	5,1	8,3	17	1" gas	3/4" gas	101	78	80	178	259
MS 152/7 P2	2SC152/7P2	80-200	40-160	8	10	10	15	21	1" gas	1" gas	111	88	150	268	349
MS 152/7 P3	2SC152/7P3	130-300	40-160	15	19	23	33	26,5	1 1/2" gas	1 1/2" gas	111	88	300	418	499
MS 152/7 P4	2SC152/7P4	150-330	40-160	10	20	15	30	32	2" gas	2" gas	121	98	430	568	649
MS 152/7 P5	2SC152/7P5	200-400	40-160	30	42	45	65	38,5	2" gas	2" gas	121	98	590	728	809
MS 152/7 P6	2SC152/7P6	100-300	40-160	21	42	35	65	44	2" gas	2" gas	121	98	720	858	939
MS 152/7 P7	2SC152/7P7	250-500	40-160	39	47	69	98	54	2" gas	2" gas	121	98	970	1108	1189
MS 152/7 P8	2SC152/7P8	250-500	40-160	48	55	88	118	62	2" gas	2" gas	121	98	1170	1308	1389
MS 152/7 P9	2SC152/7P9	250-500	40-160	55	70	97	130	70	2" gas	2" gas	121	98	1370	1508	1589

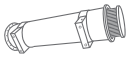

WATER FLOW RATE:



P1 P2 P3

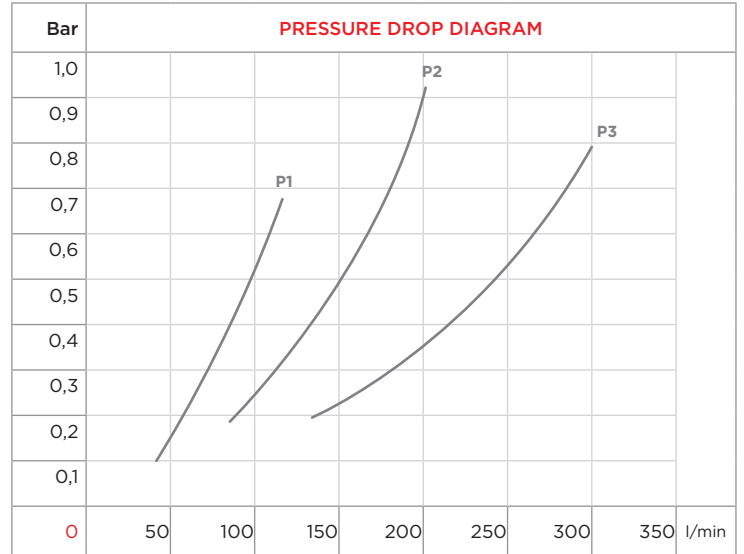
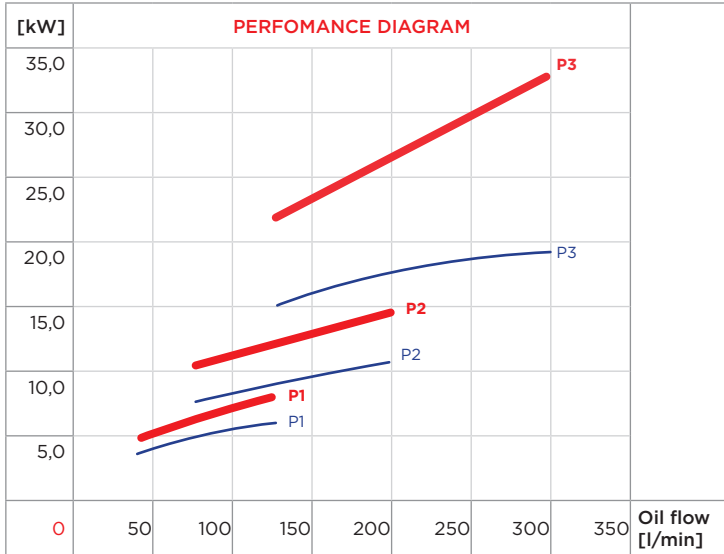

P4 P5 P6

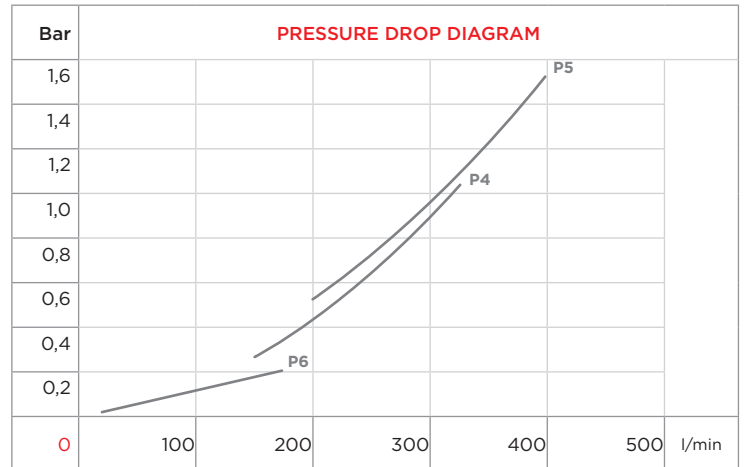
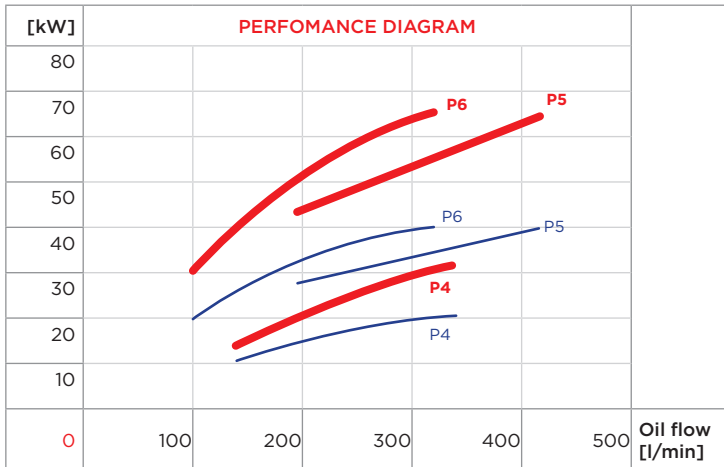

P7 P8 P9

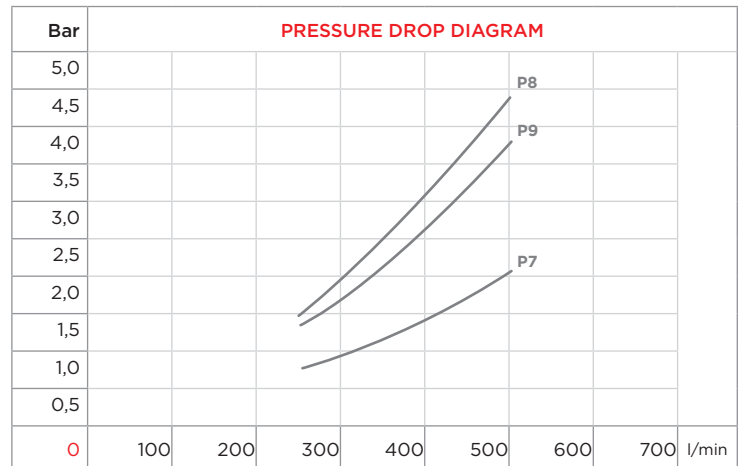
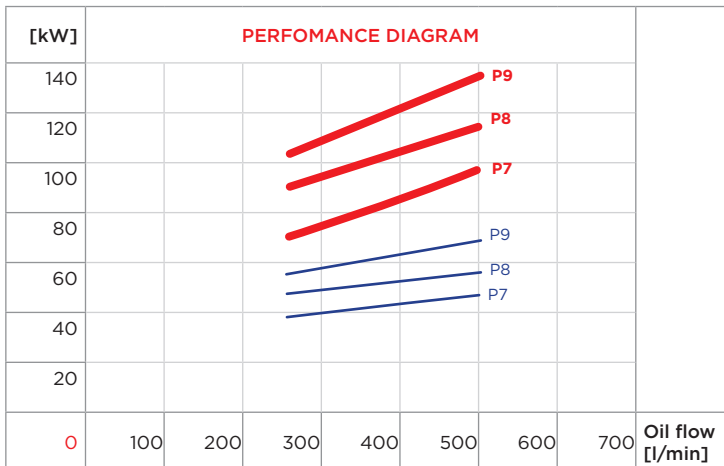

ΔT_m	10	15	20	25	30	35	40
f	2,5	1,67	1,25	1	0,83	0,71	0,63

cSt	22	30	46	68	100	150	220
f	0,4	0,6	1	1,5	2,3	3,3	4,6

MS 172/7 P

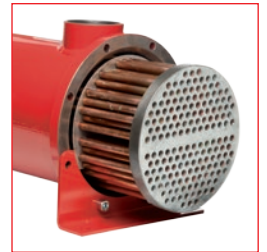
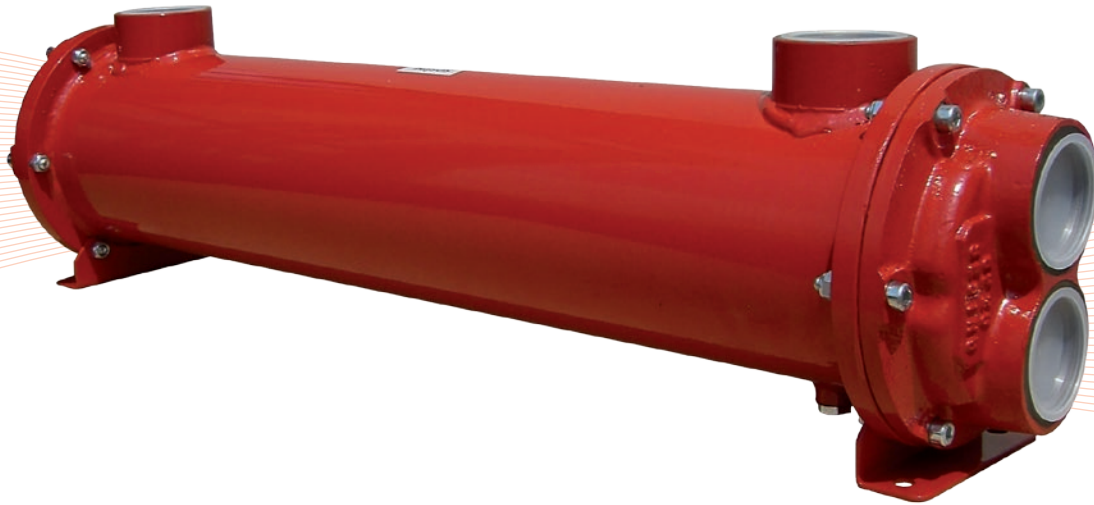
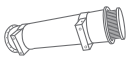

CONSTRUCTION MATERIALS		
SHELL	TUBES	END COVERS
CARBON STEEL*	COPPER*	CAST IRON*
STAINLESS STEEL	STAINLESS STEEL	STAINLESS STEEL
BRASS	CuNi (water sea)	BRONZE

- Dimensions and technical characteristics are not binding

*standard

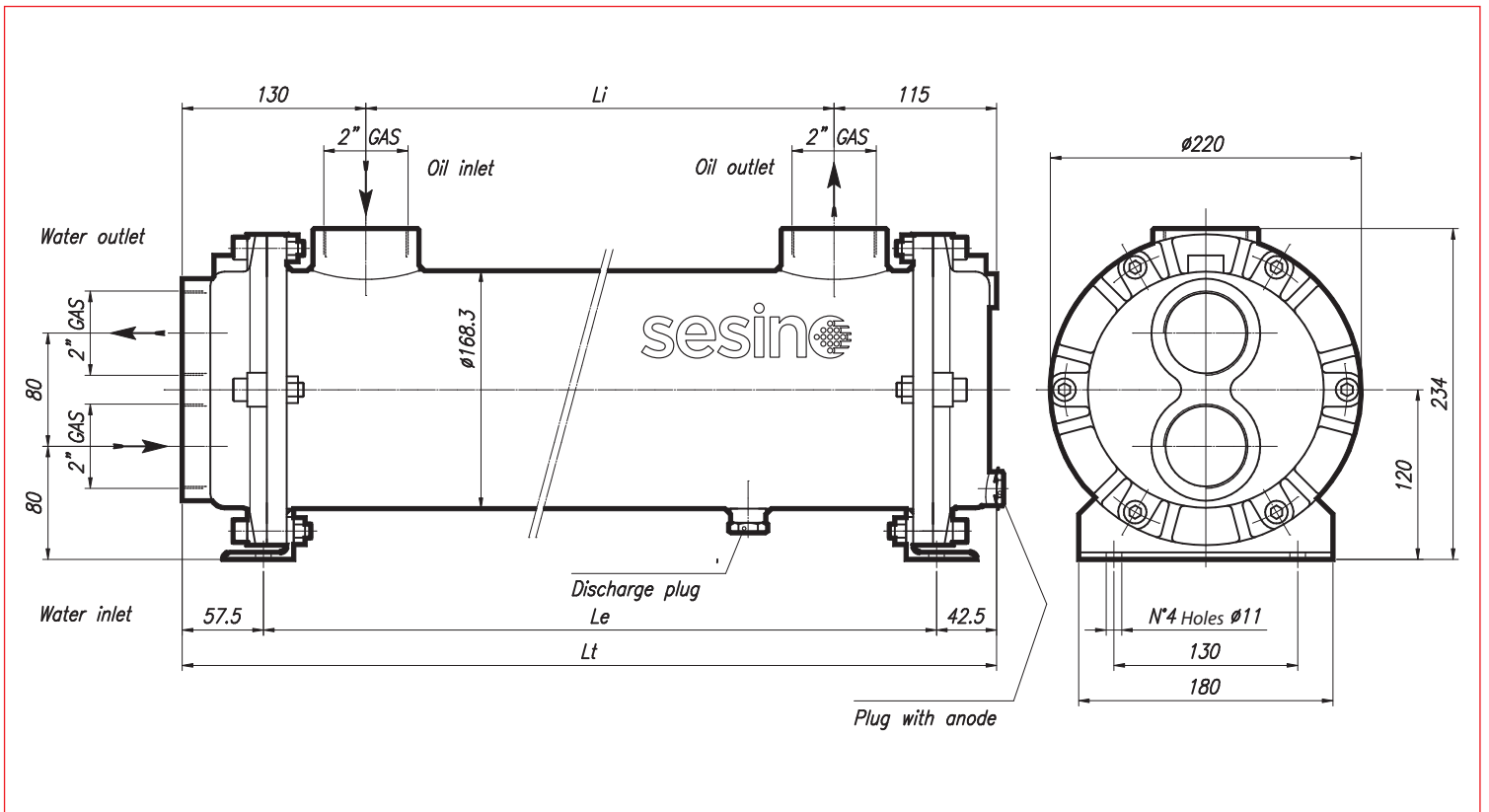

TYPE	CODE	OIL FLOW	WATER FLOW	kW MIN water flow		kW MAX water flow		WEIGHT	DIMENSIONS		
		l/min	l/min	ΔT_m 25° C		ΔT_m 25° C			kg	Li	Le
MS 172/7 P1	2SC172/7P1	100-240	67,5-270	28	34	42	60	42	355	500	600
MS 172/7 P2	2SC172/7P2	160-400	67,5-270	50	57	78	92	50,5	505	650	750
MS 172/7 P3	2SC172/7P3	260-420	67,5-270	63	71	110	136	59	655	800	900
MS 172/7 P4	2SC172/7P4	340-500	67,5-270	76	92	136	171	68,5	830	975	1075
MS 172/7 P5	2SC172/7P5	180-320	67,5-270	88	96	143	170	78	1005	1150	1250
MS 172/7 P6	2SC172/7P6	140-500	67,5-270	89	117	148	230	86	1155	1300	1400
MS 172/7 P7	2SC172/7P7	250-550	67,5-270	113	138	200	267	97	1355	1500	1600

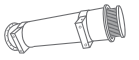

WATER FLOW RATE:



P1 P2

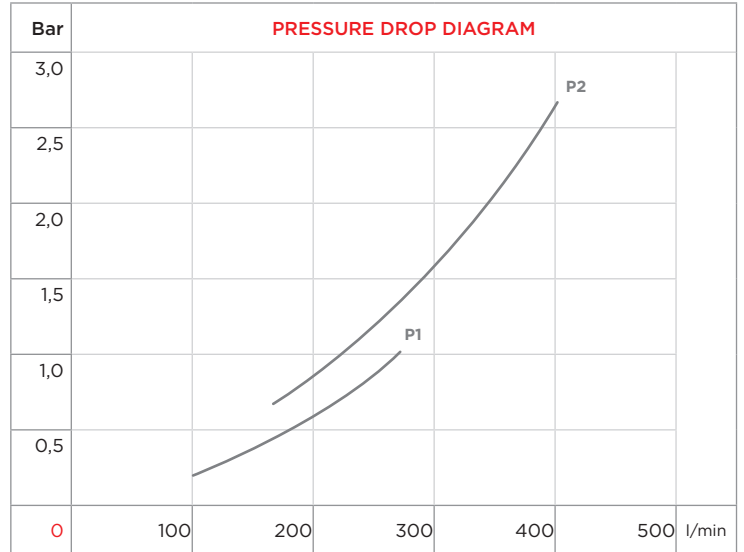
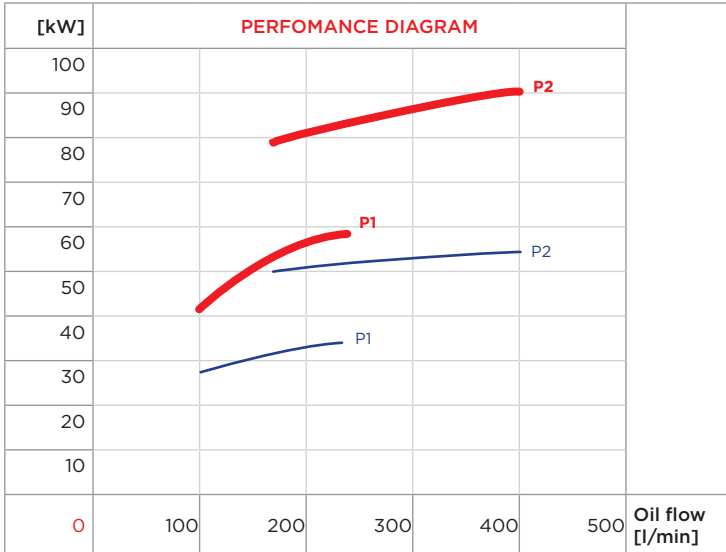

P3 P4

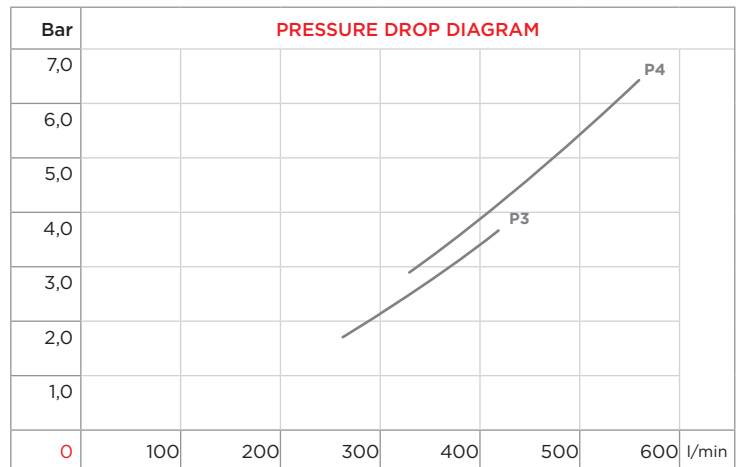
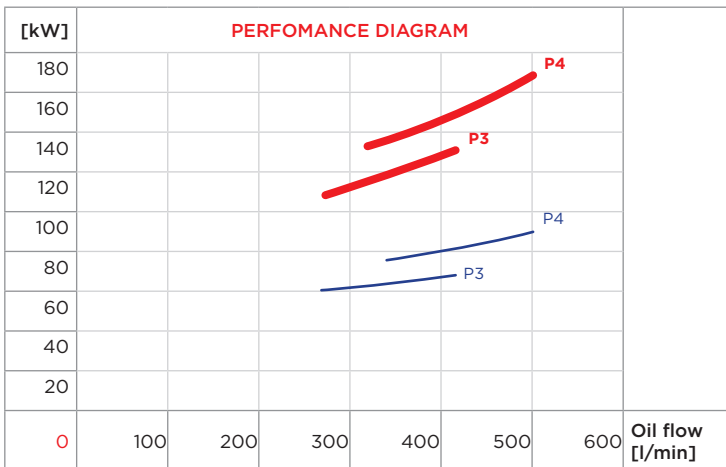

P5 P6 P7

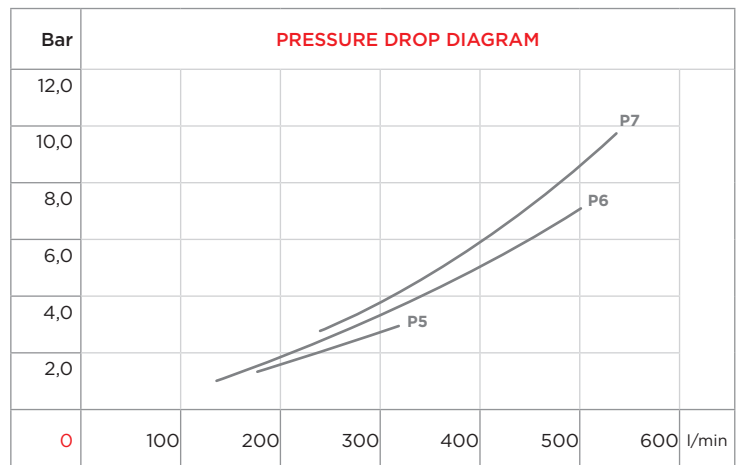
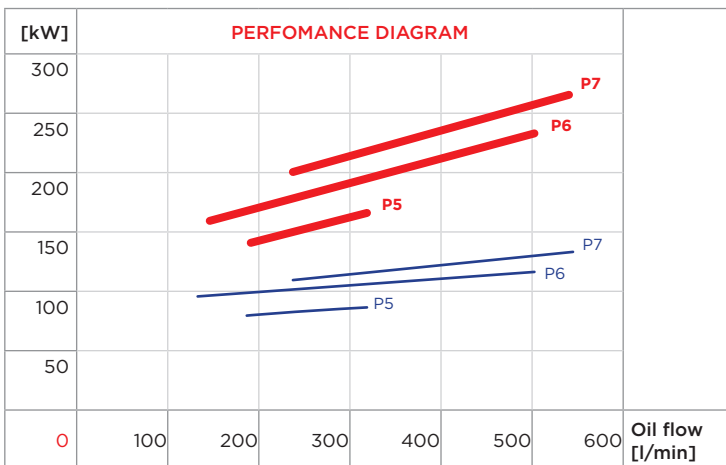

CORRECTION FACTOR							
ΔT_m	10	15	20	25	30	35	40
f	2,5	1,67	1,25	1	0,83	0,71	0,63

CORRECTION FACTOR							
cSt	22	30	46	68	100	150	220
f	0,4	0,6	1	1,5	2,3	3,3	4,6

MS 152/10 P

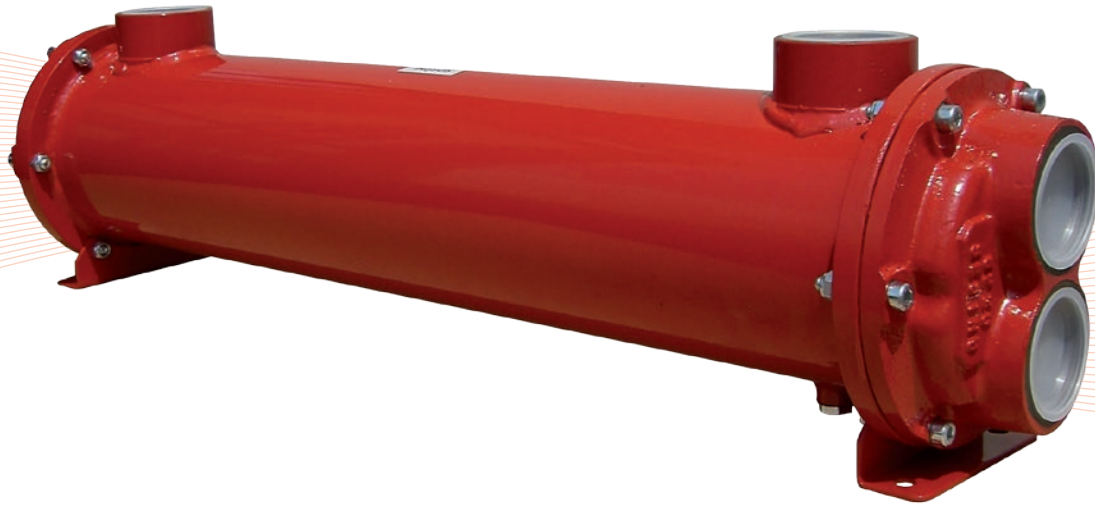
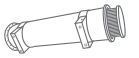

CONSTRUCTION MATERIALS		
SHELL	TUBES	END COVERS
CARBON STEEL*	COPPER*	CAST IRON*
STAINLESS STEEL	STAINLESS STEEL	STAINLESS STEEL
BRASS	CuNi (water sea)	BRONZE



- Dimensions and technical characteristics are not binding

*standard

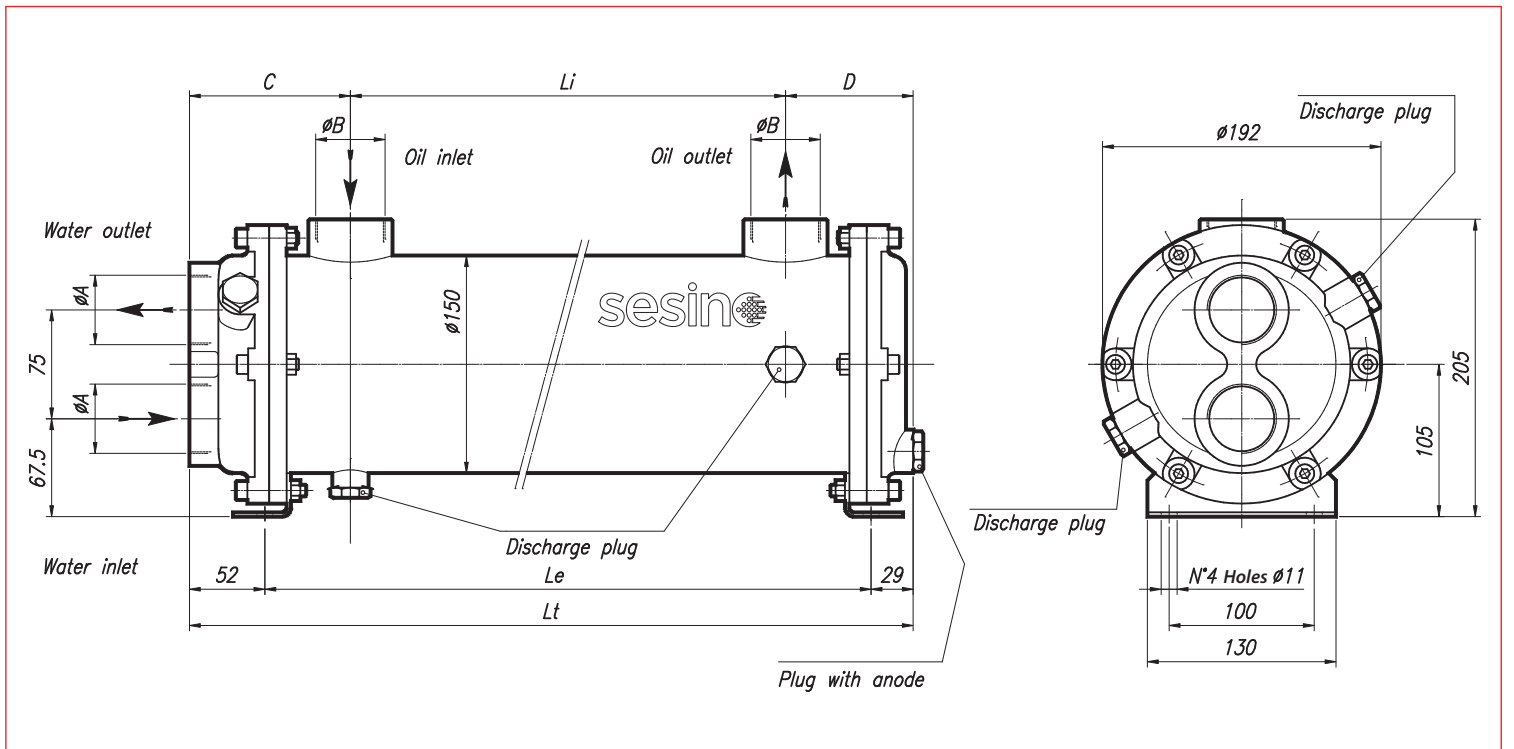

TYPE	CODE	OIL FLOW l/min	WATER FLOW l/min	kW MIN water flow		kW MAX water flow		WEIGHT kg	DIMENSIONS						
				ΔT_m 25° C	ΔT_m 25° C	ϕA	ϕB		C	D	Li	Le	Lt		
MS 152/10 P1	2SC152/10P1	30-150	40-160	2,1	3,5	2,5	4,5	16	1" gas	3/4" gas	101	78	80	178	259
MS 152/10 P2	2SC152/10P2	50-150	40-160	4	5	4,6	6	19	1" gas	1" gas	111	88	150	268	349
MS 152/10 P3	2SC152/10P3	60-250	40-160	7	10	8,5	14	24	1 1/2" gas	1 1/2" gas	111	88	300	418	499
MS 152/10 P4	2SC152/10P4	90-200	40-160	12	17	16	21	29	2" gas	2" gas	121	98	430	568	649
MS 152/10 P5	2SC152/10P5	140-260	40-160	15	20	21	30	34	2" gas	2" gas	121	98	590	728	809
MS 152/10 P6	2SC152/10P6	160-300	40-160	19	26	27	37	39	2" gas	2" gas	121	98	720	858	939
MS 152/10 P7	2SC152/10P7	100-300	40-160	15	19	31	42	47	2" gas	2" gas	121	98	858	1108	1189
MS 152/10 P8	2SC152/10P8	100-250	40-160	29	35	41	52	54	2" gas	2" gas	121	98	1108	1308	1389
MS 152/10 P9	2SC152/10P9	200-380	40-160	43	46	64	72	61	2" gas	2" gas	121	98	1308	1508	1589

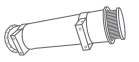

WATER FLOW RATE:



P1 P2 P3

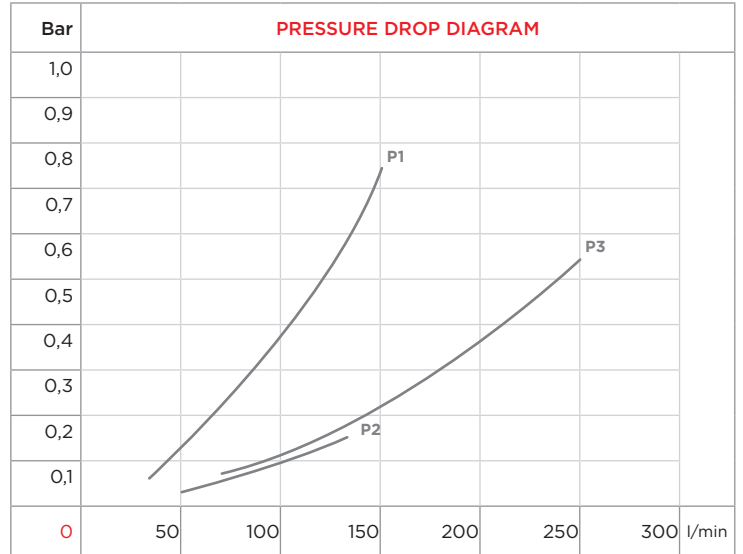
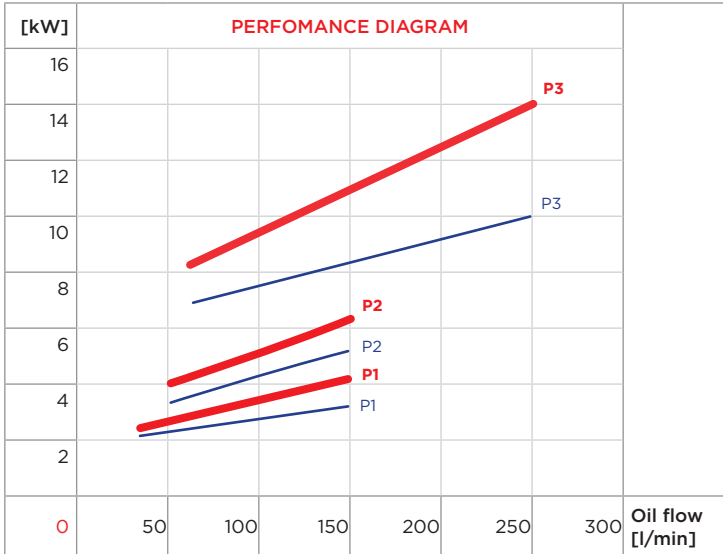

P4 P5 P6

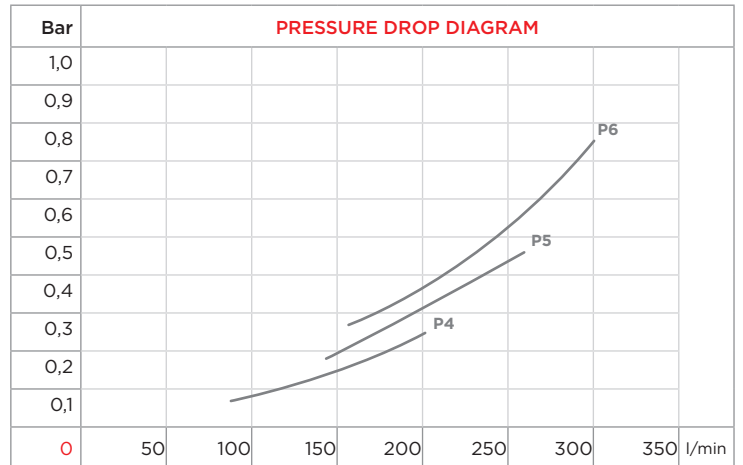
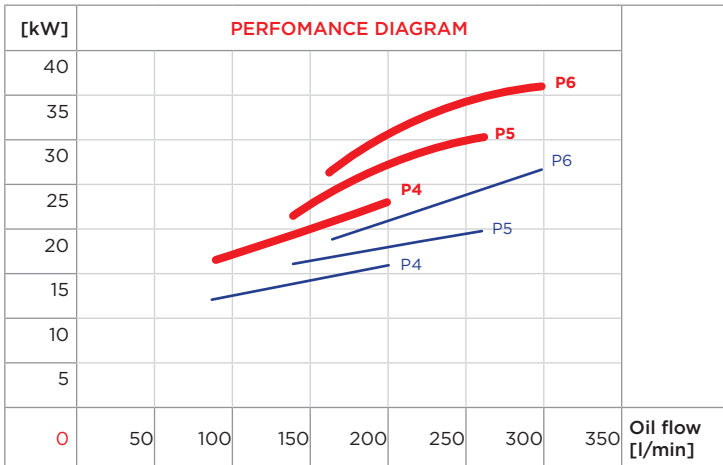

P7 P8 P9

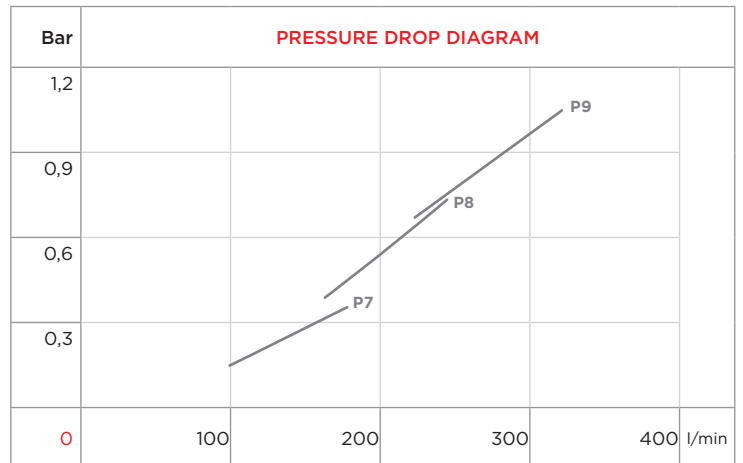
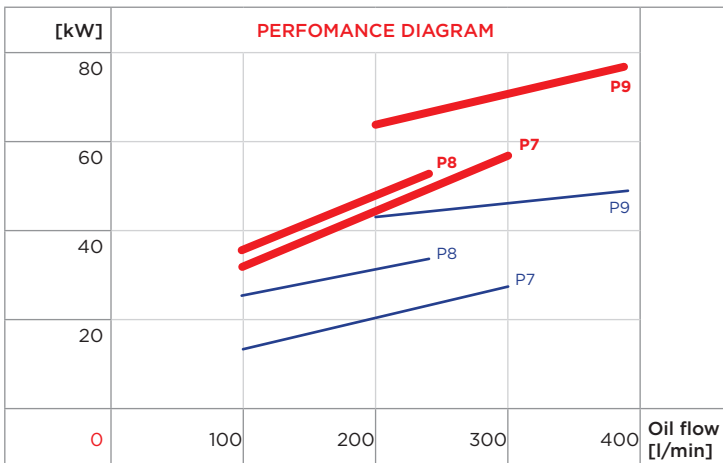

ΔT_m	10	15	20	25	30	35	40
f	2,5	1,67	1,25	1	0,83	0,71	0,63

cSt	22	30	46	68	100	150	220
f	0,4	0,6	1	1,5	2,3	3,3	4,6

MS 172/10 P

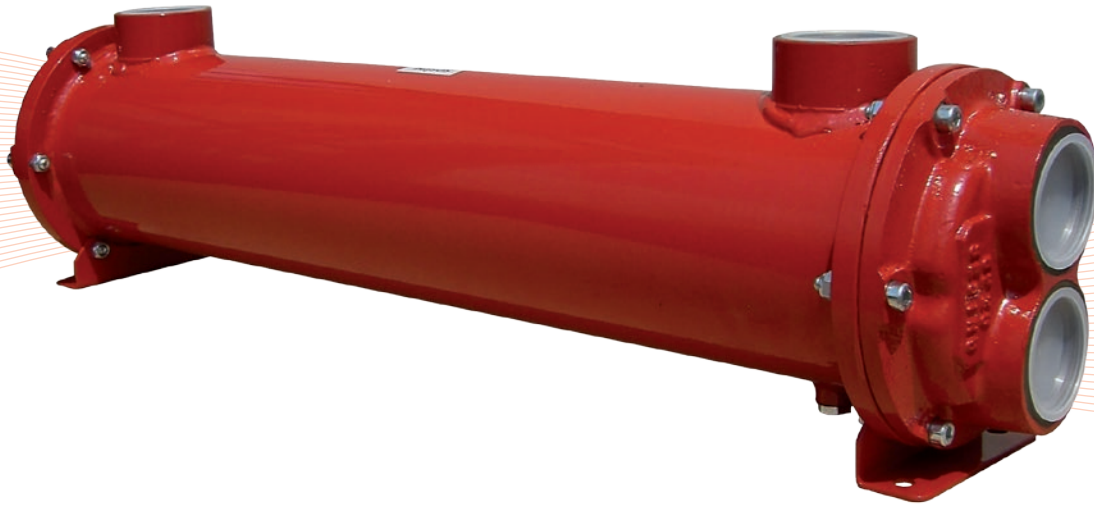
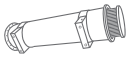

CONSTRUCTION MATERIALS		
SHELL	TUBES	END COVERS
CARBON STEEL*	COPPER*	CAST IRON*
STAINLESS STEEL	STAINLESS STEEL	STAINLESS STEEL
BRASS	CuNi (water sea)	BRONZE

- Dimensions and technical characteristics are not binding

*standard

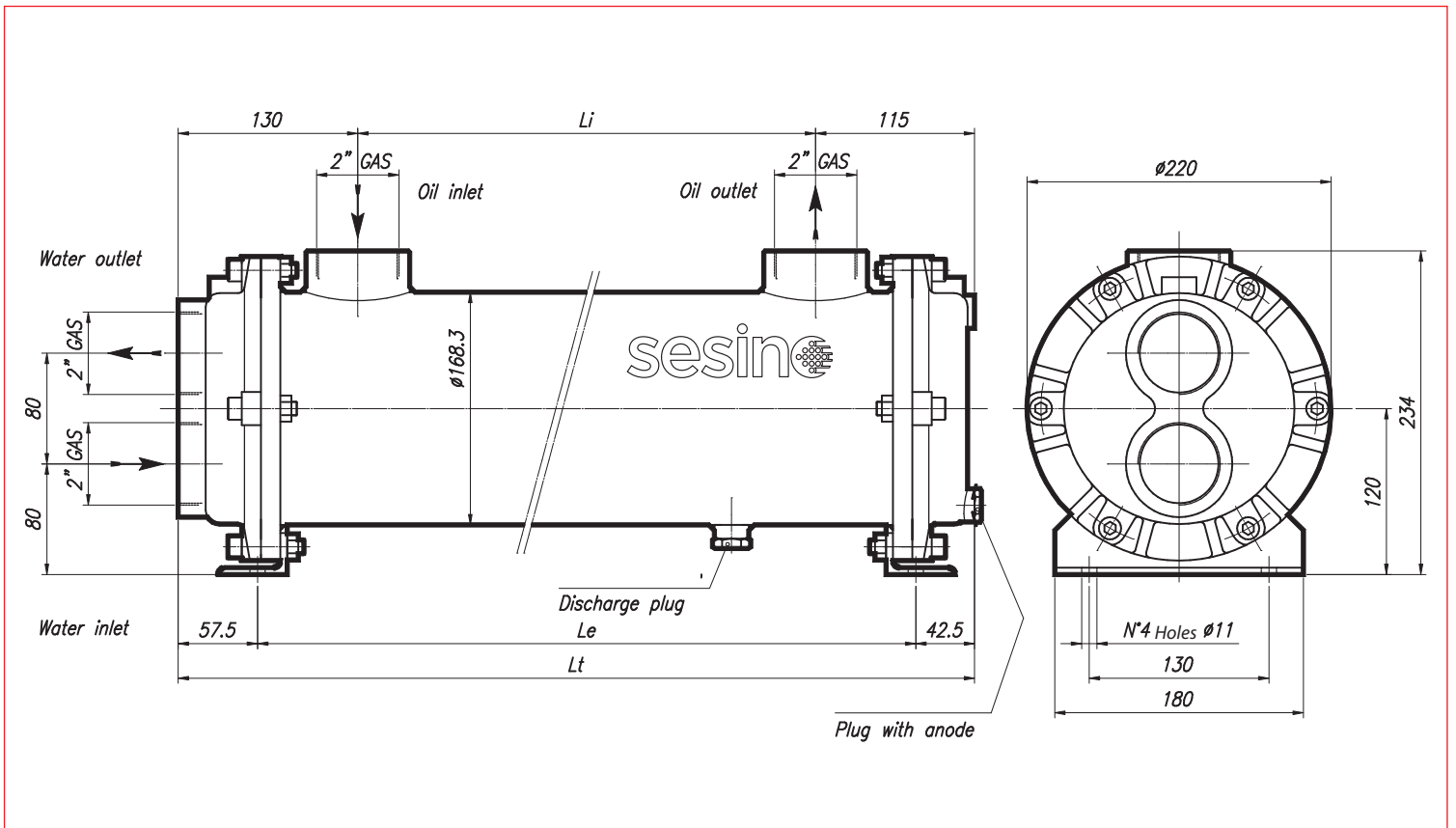

TYPE	CODE	OIL FLOW l/min	WATER FLOW l/min	kW MIN water flow		kW MAX water flow		WEIGHT kg	DIMENSIONS		
				ΔTm 25° C		ΔTm 25° C			Li	Le	Lt
MS 172/10 P1	2SC172/10P1	80-200	67,5-270	13	18	16	24	36	355	500	600
MS 172/10 P2	2SC172/10P2	200-300	67,5-270	22	28	31	41	42,5	505	650	750
MS 172/10 P3	2SC172/10P3	300-400	67,5-270	31	38	44	55	54,5	655	800	900
MS 172/10 P4	2SC172/10P4	120-280	67,5-270	26	39	35	56	63	830	975	1075
MS 172/10 P5	2SC172/10P5	280-400	67,5-270	51	57	69	88	71,5	1005	1150	1250
MS 172/10 P6	2SC172/10P6	100-300	67,5-270	46	61	61	85	79	1155	1300	1400
MS 172/10 P7	2SC172/10P7	300-500	67,5-270	69	89	90	115	88,5	1355	1500	1600

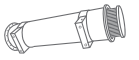

WATER FLOW RATE:



P1 P2 P3

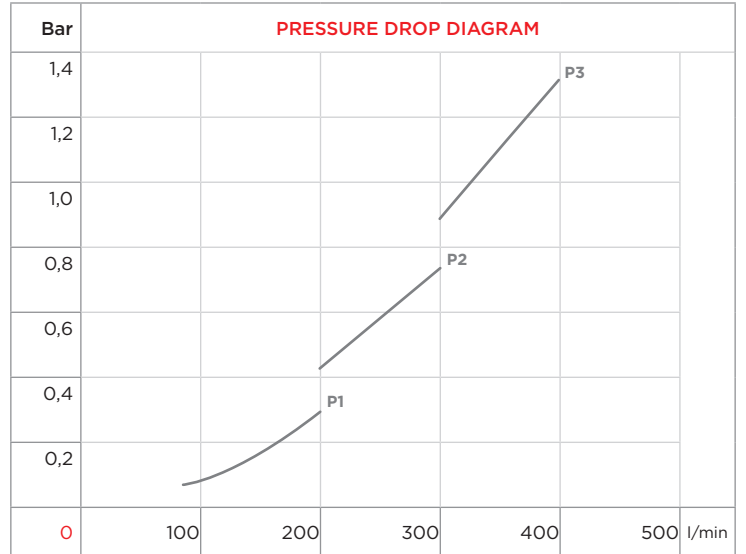
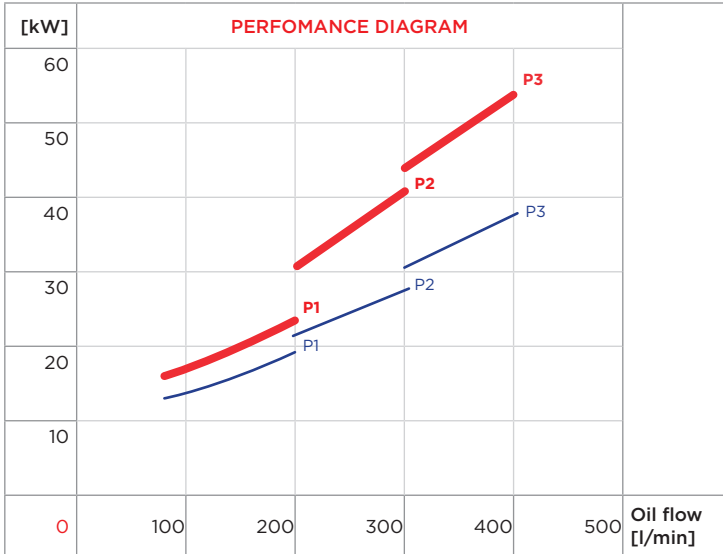

P4 P5

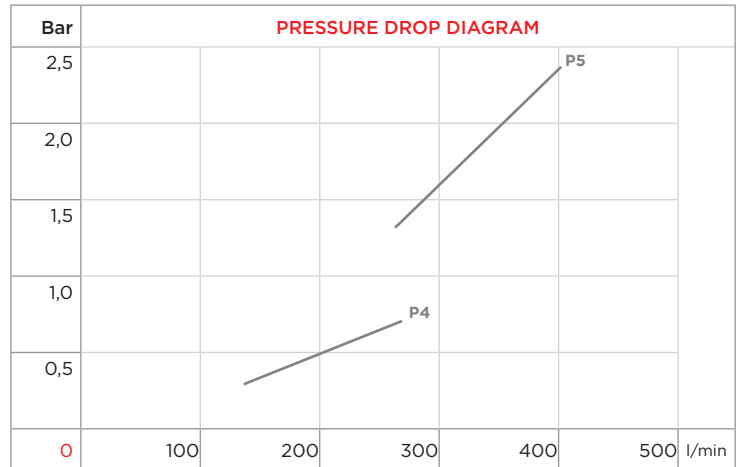
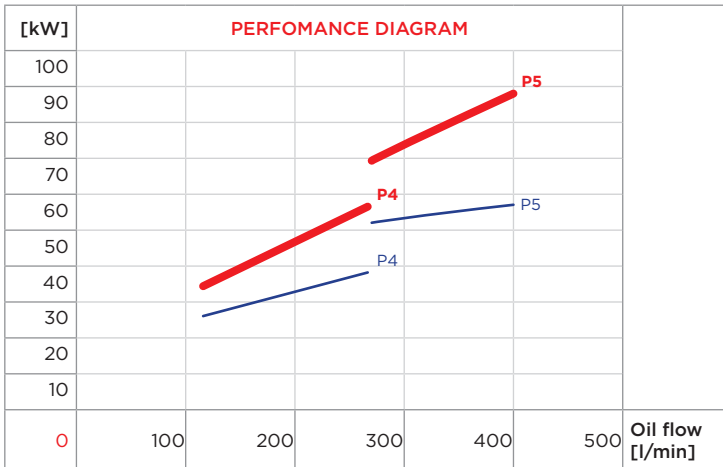

P6 P7

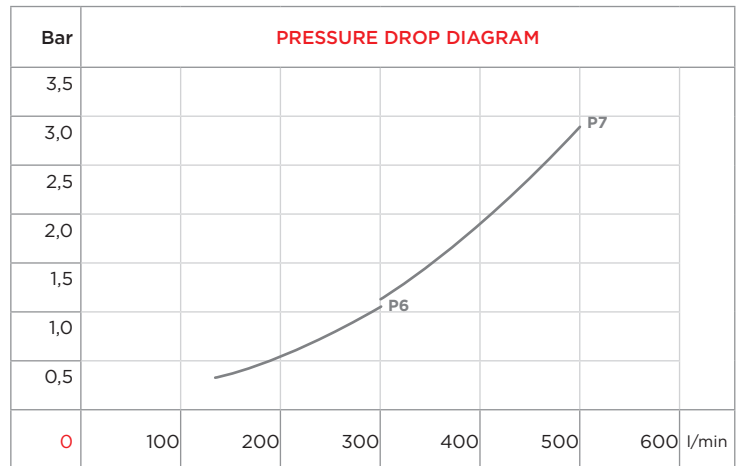
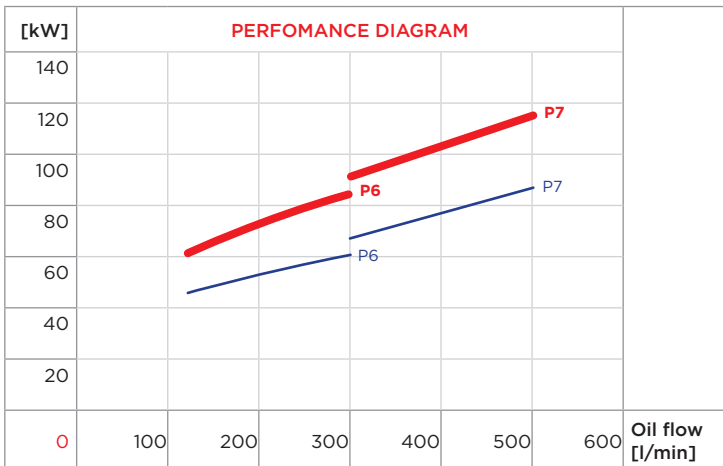

ΔT_m	10	15	20	25	30	35	40
f	2,5	1,67	1,25	1	0,83	0,71	0,63

cSt	22	30	46	68	100	150	220
f	0,4	0,6	1	1,5	2,3	3,3	4,6